



INSTALLATION DATA

110 SERIES

GAS WATER HEATER

THERMOSTAT UNI-KIT®

The Robertshaw® 110 Series Water Heater Thermostat Uni-Kit® is designed for universal replacement applications. All models feature a built-in, noncycling Energy Cut-Off (ECO) system to shut off all gas to the heater in case of excessive water temperatures. All models have a 5-1/2" sensing element and vary by inlet and outlet size, shank length, high temperature stop, and regulator type and setting. Except for R103RV models, all are available in domestic (160°F Hi-Stop) or commercial (180°F Hi-Stop) versions.

110TS - Has regulator which is less precise than R110R.

R110R - The regulator has a balancing diaphragm in addition to the main pressure regulator diaphragm.

R110RC - Same as R110R except the thermostat can be converted from use with natural to L.P. gas or L.P. to natural gas.

R103R - Same as R110R except has low capacity (35,000 BTU) for use on recreational vehicles.

THERMOSTAT IDENTIFICATION BY GAS COCK DIAL TYPE

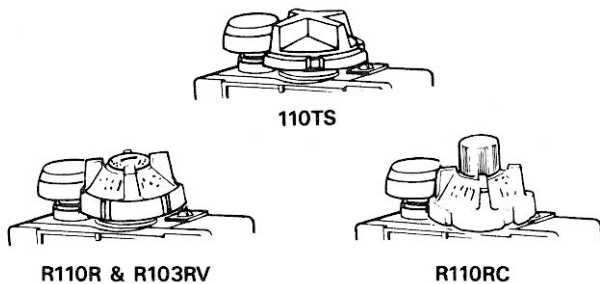

CAUTION
 THIS DEVICE SHOULD BE INSTALLED BY A QUALIFIED TECHNICIAN WITH DUE REGARD FOR SAFETY AS IMPROPER INSTALLATION COULD RESULT IN A HAZARDOUS CONDITION.

INSTALLATION INSTRUCTIONS

Turn off gas to equipment before servicing.

1. Shut off water supply to heater and all hot water outlets.
2. If changing from natural to L.P. or L.P. to natural gas, the burner and pilot orifices must also be changed.
3. If replacing a model R110RC convertible thermostat, set the control for the gas being used. As shown in the figure below, remove the slotted cap on the gas cock dial. Insert a small screwdriver blade into slotted plunger. Depress the plunger fully and rotate 90° to "LP" or "NAT" as desired. Replace the slotted cap and tighten with screwdriver. **NOTE:** Some O.E.M. models of the convertible 110 have a pilot regulator, which must also be changed. The model offered by Uni-Line does not have this regulator.

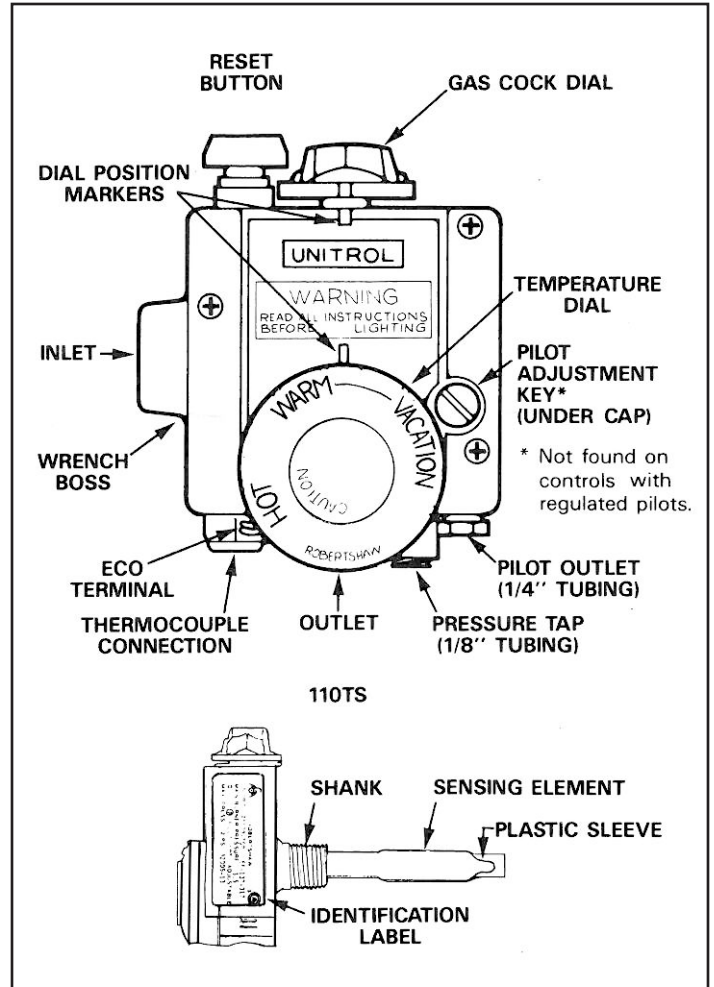
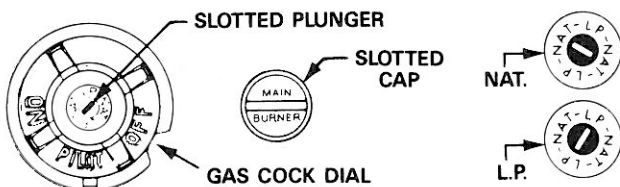

4. **DO NOT** remove the protective plastic sleeve from the copper sensing tube. Apply a small amount of pipe thread compound to the brass shank threads. Remove the defective thermostat and install the new unit. **DO NOT** use a pipe wrench on the control body. Recommended method to tighten the thermostat is to screw a short (8"-10") piece of correctly sized pipe into the INLET boss and use this pipe as a handle. Insertion of any other object can cause internal damage resulting in a hazardous condition.
5. Prior to connecting piping to the thermostat, check inlet gas pressure to make sure it does not exceed 1/2 psi (14" W.C.). High pressure can damage the control causing a hazardous condition.
6. If it is not already installed, a drip leg (sediment trap) should be added to the gas supply line to the control. (See figure below.) All piping must comply with local codes and ordinances and with National Fuel Gas Code (ANSI Z223.1/NFPA, No. 54).

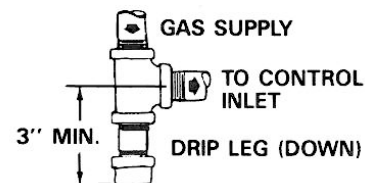

INSTALLATION INSTRUCTIONS (Cont'd)

7. Make sure that the piping is clean and free from scale and burrs. To the gas inlet pipe, apply a small amount of good quality pipe thread compound which is suitable for the type gas being used. (**NOTE:** Do not use Teflon tape or Teflon compound.) Connect piping to inlet and outlet of control. Thread compound should be used sparingly and on male threads only, leaving first two threads clean. Pipe dope or thread compound should never be used on female threads as it may be pushed into control body, possibly causing the valve to stick or fail to close. **CAUTION:** Do not use pipe compound on outlet pipe connections when control has "flare" outlet.
8. Connect pilot line making sure it is free of burrs and dirt. Use fitting provided and tighten for gas seal. **DO NOT** bend tubing after tightening.
9. Connect thermocouple. The thermocouple nut should be started and turned all the way in by hand. An additional quarter turn with a small (4") wrench will then be sufficient to set the lock washer. **DO NOT** overtighten nuts as this may damage the thermocouple or magnet and is unnecessary.
10. Leak test after installation with main burner "ON" and "OFF."
Coat pipe and tubing joints with soap solution. Bubbles indicate leaks that must be corrected.

OPERATING INSTRUCTIONS

LP. GAS WARNING

To avoid possible injury, fire and explosion, please read and follow these precautions and all instructions on appliance before lighting the pilot. L.P. (Propane) gas is heavier than air and will remain at **floor level** if there is a leak. Before lighting, sniff at **floor level. If you smell gas**, follow these rules:

1. Get all people out of building.
2. **DO NOT** light matches. **DO NOT** turn electric lights or switches on or off in area. **DO NOT** use an electric fan to remove gas from area.
3. Shut off gas at L.P. tank outside of building.
4. Telephone gas company and fire department. Ask instructions. Before hanging up, give your name, address, and phone number. **DO NOT** go back into building. If help is coming wait for them to arrive.

If L.P. tank runs out of fuel, turn off gas at the appliance. After L.P. tank is refilled, appliance must be relit according to manufacturer's instructions. If the gas control has been exposed to **WATER** in any way, **DO NOT** try to use it. It must be replaced. **DO NOT** attempt repair on gas control or appliance.

Tampering is **DANGEROUS** and voids all warranties.

TO TURN WATER HEATER ON

1. Turn gas cock dial clockwise to "OFF" position.
2. Turn temperature dial to its lowest temperature setting.
CAUTION: Temperature dial, gas cock, and reset button should only be operated by hand. If more force is required, control should be replaced. Never use any tools.
3. Remove burner outer and inner door.
4. **CAUTION:** Wait five minutes to allow gas which may have accumulated in burner compartment to escape. (See WARNING to the left for L.P. applications.)
5. If you don't smell gas, turn gas cock dial counterclockwise to "PILOT" position.
6. Hold lighted match at pilot burner. **CAUTION:** If pilot lights without depressing reset button, replace control. Depress and hold reset button down completely and light the pilot. Continue to hold the

reset button down for about one (1) minute after the pilot is lit. Release reset button and it will pop back up. Pilot should remain lit. If it goes out, repeat steps 4 and 6. **CAUTION:** If reset button does not pop up when released or if pilot will not stay lit after several tries, turn the gas control knob to "OFF", and test system as explained under SERVICE INSTRUCTIONS - AUTOMATIC PILOT SYSTEM.

7. Replace burner inner and outer door.
8. Turn gas control knob counterclockwise to "ON" position.
9. Set water temperature dial to desired temperature.

CAUTION: Hotter water increases the risk of scald injury.

TO SHUT WATER HEATER OFF

1. Turn temperature dial to lowest setting.
2. Turn gas cock dial to "OFF." Do not force.
3. IF CONTROL FAILS TO TURN OFF, shut off gas ahead of control at line valve or meter. Replace control.

SERVICE INSTRUCTIONS



CAUTION

WE RECOMMEND REPAIR AND ADJUSTMENTS BE LIMITED TO THE OPERATIONS LISTED, WHICH OUR EXPERIENCE SHOWS ARE PRACTICAL SERVICE OPERATIONS.

CAUTION: If control has been exposed to water in any way, it must be replaced.

PILOT BURNER ADJUSTMENT

NOTE: Pilot cannot be adjusted on controls with a pilot regulator. Such controls are easily identified because they do not have a pilot adjustment key.

1. Remove Pilot Adjustment Cap.
2. Adjust Pilot Key to provide properly sized flame on the thermocouple. The flame should cover the upper 3/8" of the tip.
3. Replace Pilot Adjustment Cap.

CAUTION: The gas cock must be in either the "OFF", "PILOT" or full "ON" position. Do not use it to adjust gas flow. An incorrect burner flame can result.

MAIN BURNER PRESSURE REGULATOR ADJUSTMENT - R110R & R103RV ONLY

The main burner pressure regulator adjustment screw slot is filled to seal the factory pressure setting. The regulator should never need adjustment.

If however, the main burner flame appears too high or too low, the main gas pressure regulator may be checked and adjusted by a qualified serviceman:

Attach manometer or pressure gauge to outlet pressure tap. With main burner "ON" outlet pressure should equal "main burner pressure" specified on side of control. If it does not, adjust the regulator as follows:

1. Remove regulator adjustment cap by inserting screwdriver in slot and rotating counterclockwise. (See figure on page 3.)
2. With small screwdriver, remove sealant from adjustment screw slot if necessary.
3. Watching manometer, rotate adjustment screw clockwise to increase, or counterclockwise to decrease pressure.
4. Replace regulator adjustment cap and outlet pressure cap.

CAUTION: The gas cock must be in either the "OFF", "PILOT", or full "ON" position. Do not use it to adjust gas flow. An incorrect burner flame can result.

SERVICE INSTRUCTIONS (Cont'd)

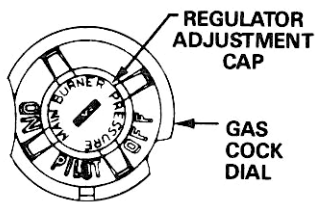

**CAUTION: DO NOT PRY ON GAS COCK DIAL.
DAMAGE WILL RESULT.**

AUTOMATIC PILOT SYSTEM

There are four major causes of pilot outage in the automatic pilot systems:

1. ECO contacts have opened due to an over-temperature condition.
2. Improper pilot operation.
3. Low output thermocouple.
4. Inoperative automatic pilot magnet.

ECO Check

1. Remove thermocouple from control.
2. Set test meter for continuity check. (OHMS)
3. Attach alligator clip to pilot tubing. (See figure below.)
4. Insert probe fully into magnet opening where thermocouple was attached. Be sure probe is straight and apply a slight upward pressure. Make sure probe touches only the contact in the center of the magnet, and not the thermocouple threading. (Wrap probe with tape to within 1/32" of tip.)

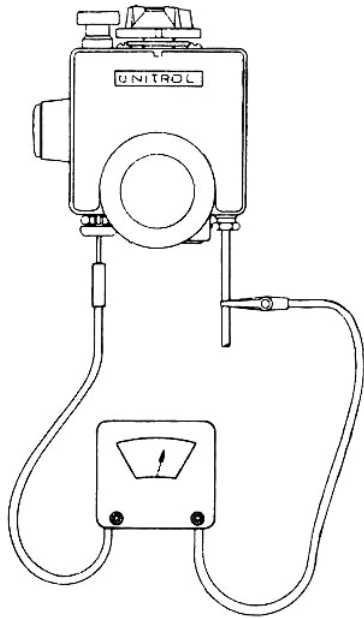

5. If continuity is indicated, Energy Cut-Off is good. If continuity is not indicated, replace control. DO NOT operate the control with the ECO removed from circuit as this will create an unsafe condition.

CAUTION: The ECO is designed to open due to an over temperature situation. If ECO is shown to be open (no continuity), determine nature of cause and correct before installing replacement control.

Thermocouple Check

1. Check for proper pilot operation. Flame should cover the upper 3/8" of the thermocouple tip.
2. Unscrew thermocouple from control.
3. Screw Robertshaw adaptor 10-038 into control.
4. Screw thermocouple into adaptor.
5. Connect millivolt meter leads to adaptor and thermocouple as shown in figure below.
6. Light pilot and allow it to heat tip of thermocouple for three minutes. If pilot will not stay lit, hold red reset button down during this test.
7. If meter reads below 13 millivolts, replace thermocouple. If meter reads 13 millivolts or more, the thermocouple is good.

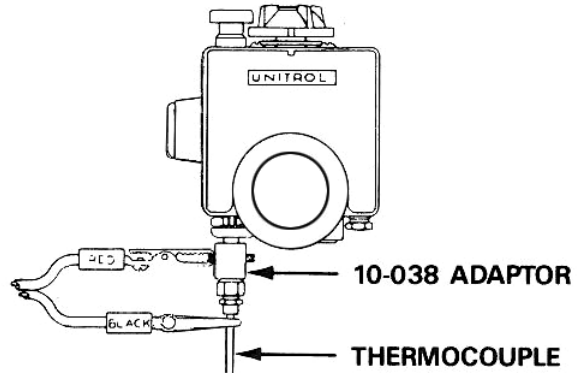

Magnet Check

1. After testing thermocouple and replacing if necessary as described above, and checking Energy Cut-Off, follow normal pilot lighting procedure with adaptor and millivolt meter attached as shown for thermocouple check.
2. Allow pilot to burn for three minutes.
3. Note millivolt reading on meter and blow out pilot.
4. Magnet should continue to hold for a drop of five millivolts or more before it releases. A "snap" can be heard when magnet releases. If magnet does not hold for a drop of at least five millivolts, replace control. Magnet is good if it holds for a drop of five millivolts or more.

SERVICE INSTRUCTIONS (Cont'd)

TROUBLESHOOTING

1. Discuss complaint with users to get their version of problems.
2. Refer to water heater manufacturer instructions.
3. Inspect water heater and surrounding area.
4. Check for gas leaks, water leaks, soot, drafts, availability of fresh air.
5. Note temperature dial setting, and gas cock knob position.
6. Check main burner flame and pilot flame characteristics.

The chart below shows a partial list of problems and possible cures.

Problems													Possible Causes	Possible Cures			
PILOT LIGHTS WITHOUT DEPRESSING RESET BUTTON	DELAYED IGNITION	SOOTING	BURNER FLAME YELLOW LAZY	BURNER FLAME NOISY	BURNER FLAME TOO HIGH	BURNER POPS OFF	FLAME IN MIXING TUBE	PILOT WILL NOT STAY ON	NOT ENOUGH HOT WATER	HEATS TOO SLOWLY	BURNER WILL NOT COME ON	BURNER WILL NOT SHUT OFF			BURNER FLAME FLOATS	COMBUSTION ODORS	WATER TOO HOT
				•		•										TOO MUCH PRIMARY AIR	ADJUST AIR SHUTTER
	•	•	•						•	•				•	•	NOT ENOUGH PRIMARY OR SECONDARY AIR	ADJUST AIR SHUTTER AND SUPPLY
	•	•	•			•	•		•	•	•			•		DIRT IN BURNER ORIFICE	CLEAN ORIFICE
	•	•	•				•			•	•			•	•	BURNER VENTURI & PORTS CLOGGED	CLEAN VENTURI & PORTS
	•		•		•				•	•				•	•	WRONG ORIFICE	INSTALL CORRECT ORIFICE
								•	•	•						DRAFTS	SHIELD OR ELIMINATE DRAFT
		•	•					•	•	•				•	•	CLOGGED FLUE	CLEAN FLUE
•								•			•					DEFECTIVE MAGNET VALVE	REPLACE THERMOSTAT
								•			•					FAULTY THERMOCOUPLE	REPLACE THERMOCOUPLE
								•			•					POOR THERMOCOUPLE CONNECTION	CLEAN AND RETIGHTEN
	•							•			•					PILOT LINE OR ORIFICE CLOGGED	CLEAN PILOT LINE AND ORIFICE
	•							•								WRONG PILOT SIZE OR LOCATION	CHECK ORIFICE OR RELOCATE PILOT
								•			•					PILOT FLAME NOT ON THERMOCOUPLE	ADJUST PILOT
	•	•	•	•	•	•	•	•	•	•				•	•	IMPROPER GAS PRESSURE	ADJUST PRESSURE REGULATOR
		•				•	•						•	•		DIRT ON VALVE SEAT	REPLACE THERMOSTAT
								•	•		•					NO GAS	CHECK GAS SUPPLY
								•	•							HEATER UNDERSIZED	INSTALL LARGER HEATER
	•	•	•		•		•	•	•	•	•	•		•		FAULTY THERMOSTAT	REPLACE THERMOSTAT
								•	•		•					ENERGY CUT-OFF OPEN	CHECK ENERGY CUT-OFF †
								•	•	•						THERMOSTAT SET TOO LOW	SET TO HIGHER TEMPERATURE *
														•		THERMOSTAT SET TOO HIGH	SET TO LOWER TEMPERATURE
	•	•	•	•	•	•	•	•	•	•						INCORRECT CONVERTIBLE SETTINGS	CHECK MAIN & PILOT CONVERTIBLE SETTINGS

† An open E.C.O. circuit is not a cause for warranty replacement.

* CAUTION: Hotter water increase the risk of scald injury.



Customer Service Telephone 1.800.304.6563
 Customer Service Facsimile 1.800.426.0804
 HVACCustomerService@robertshaw.com

For Technical Service
 Telephone 1.800.445.8299
 Facsimile 1.630.260.7294
 TechnicalService@robertshaw.com

Robertshaw®, Ranco®, Paragon® and Uni-Line® are trademarks of Robertshaw, its subsidiaries and/or affiliated companies. All other brands mentioned may be the trademarks of their respective owners.

www.uni-line.com
 www.robertshaw.com
 ©2014 Robertshaw
 08/14 -1-113 RevF