

RTP SERIES

Condensate Removal Pumps

INTRODUCTION

Your RTP Tank Pump is designed as an automatic condensate removal pump for water dripping off an air conditioner evaporative coil. The pump is controlled by a float/switch mechanism which turns the pump on when approximately 2¼" of water collects in the tank, and automatically switches off when the tank drains to approximately 1¼".

The RTP Tank Pump you have purchased is of the highest quality workmanship and material. It has been engineered to give you long and reliable service.

RectorSeal pumps are carefully packaged, inspected and tested to ensure safe operation and delivery. When you receive your pump, examine it carefully to determine that there are no broken or damaged parts that may have occurred during shipment. If damage has occurred, make notation and notify the firm that you purchased the pump from. They will assist you in replacement or repair, if required.

READ INSTRUCTIONS CAREFULLY BEFORE ATTEMPTING TO INSTALL, OPERATE OR SERVICE THE RECTORSEAL RTP TANK PUMP. KNOW THE PUMP APPLICATION, LIMITATIONS AND POTENTIAL HAZARDS. PROTECT YOURSELF AND OTHERS BY OBSERVING ALL SAFETY INFORMATION. FAILURE TO COMPLY WITH INSTRUCTIONS COULD RESULT IN PERSONAL INJURY AND/OR PROPERTY DAMAGE! RETAIN INSTRUCTIONS FOR FUTURE REFERENCE. INSTALLATION AND CONNECTIONS ARE TO BE MADE BY A QUALIFIED PERSON.

SAFETY GUIDELINES

WARNING DO NOT USE TO PUMP FLAMMABLE OR EXPLOSIVE FLUIDS SUCH AS GASOLINE, FUEL OIL, KEROSENE, ETC. DO NOT USE IN EXPLOSIVE ATMOSPHERES. DO NOT SUBMERGE. PUMP SHOULD BE USED WITH LIQUIDS COMPATIBLE WITH PUMP COMPONENT MATERIALS. DO NOT HANDLE PUMP WITH WET HANDS OR WHEN STANDING ON A WET OR DAMP SURFACE, OR IN WATER. THIS PUMP IS SUPPLIED WITH A GROUNDING CONDUCTOR AND/OR GROUNDING TYPE ATTACHMENT PLUG, TO REDUCE THE RISK OF ELECTRICAL SHOCK, BE CERTAIN THAT IT IS CONNECTED TO A PROPERLY GROUNDED GROUNDING TYPE RECEPTACLE. IN ANY INSTALLATIONS WHERE PROPERTY DAMAGE AND/OR PERSONAL INJURY MIGHT RESULT FROM AN INOPERATIVE OF LEAKING PUMP DUE TO POWER OUTAGES, DISCHARGE LINE BLOCKAGE, OR ANY OTHER REASON, A BACKUP SYSTEM(S) AND/OR ALARM SHOULD BE USED.

SUPPORT PUMP AND PIPING WHEN ASSEMBLING AND WHEN INSTALLED. FAILURE TO DO SO MAY CAUSE PIPING TO BREAK PUMP TO FAIL, MOTOR BEARING FAILURES, ETC.

INSTALLATION

1. Before installing pump, allow air conditioner to cycle several times, collecting condensate in a separate container to help flush any residual oils that may remain in the system.
2. Carefully unpack the pump. Remove the cardboard packing from the motor cover air slots. Carefully slide the packing away from the pump. This packing is used to prevent switch movement during shipment (Figure 1).
3. Mounting the pump: the tank has two slots provided to mount the unit. The slots are located on the ends of the tank (Figure 5). The unit should be mounted either on the side of the air conditioner unit or nearby wall. Pump must be level and the inlet must be below the coil drain. Conduit fittings are not compatible with the plastic pump housing.
4. The pump should not be installed in a manner that will subject it to splashing or spraying.
5. This pump is not intended for use inside air plenums.

Figure 1

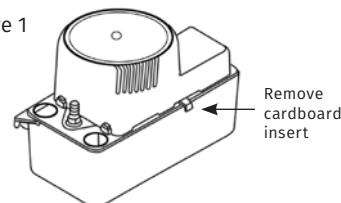

Figure 2

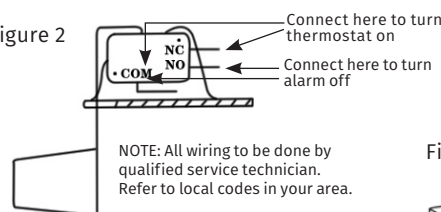

Figure 3

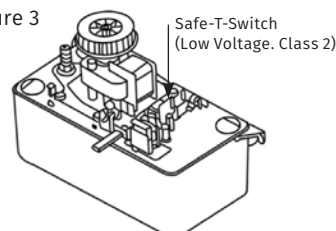

Figure 4

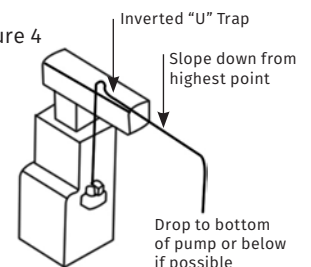
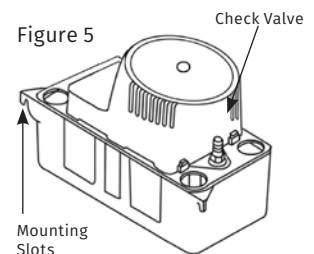

Figure 5



ELECTRICAL CONNECTIONS

WARNING

1. Shut off electrical power at fuse box before making any connections. All wiring must comply with local codes.
2. Line voltage: Connect power cord to line voltage specified on motor and nameplate. Power cord must be connected to a constant source of power (not a fan or other device that runs intermittently). If power cord does not have a plug, wiring is as follows: green (or green/yellow)—ground. Black (or brown)—line. White (or blue)—neutral.
3. Safety switch: The safety overflow switch should be connected to a class II low voltage circuit. To control a thermostatic circuit the COM and NC connections from the safety switch are to be wired in series with the low voltage thermostat circuit to shut down the heating/AC circuit. The COM and NO switch contacts may be used to actuate a low voltage alarm circuit (connected in series) if the heating/cooling system cannot be disrupted. The safety switch comes from the factory with leads connected to the COM and NO switch terminals. Typical hook-up of “NC” circuits would be (Figures 2 & 3).
4. If fused plug is used on 230 V units, a 1.0 amp fuse is recommended (not included in the package).

PIPING

1. Run flexible tubing or pipe from evaporator drain into one of the three pump inlets. Be sure inlet piping is sloped downward to allow gravity flow (Figure 4). Extend the inlet piping into the tank from 1 to 3 inches to ensure that it will not interfere with proper float operation. Be sure that the inlet piping is cut at an angle where it enters the tank.
2. The outlet piping should be flexible tubing secured with a hose Clamp (not provided) or pipe (3/8 inch ID. maximum to prevent excessive flow back to unit). From condensate unit, extend discharge piping straight up as high as necessary. Do not extend this line above the head/GPH of the particular model being installed. From this high point, slope discharge line down slightly to a point above drain area; then turn down and extend to a point below or approximately level with the bottom of the condensate unit. This will give a siphoning effect which will improve efficiency of the condensate unit and will, in most cases eliminate the need for a check valve (Figure 5). If it is not possible to slope discharge line down, make an inverted “U” trap directly above the pump at the highest point.

SERVICE INSTRUCTIONS

WARNING

1. Make certain that the unit is disconnected from the power source before attempting to service or remove any component!
2. Be sure the floats move freely. Clean as necessary (Figure 6).
3. Clean the tank with warm water and mild soap.
4. Check the inlet and outlet piping. Clean as necessary. Be sure there are no kinks in the line that would inhibit flow.

TESTING

1. Turn on power.
2. Remove motor/tank cover assembly and hold level.
3. Test motor switch by raising motor switch float with finger (Figure 6). Motor should turn on just before float contacts cover.
4. Test safety switch by raising safety switch float with finger. Safety switch should activate before float contacts cover.
5. Replace motor/tank cover assembly on tank.

This pump is suitable for gas furnace condensate applications. Caution must be taken to ensure acidity of condensate does not increase below the average pH of 3.4 (to prevent localized pocket of acid that acts like a battery causing pitting) by routinely cleaning or flushing tank with fresh water.

Figure 6

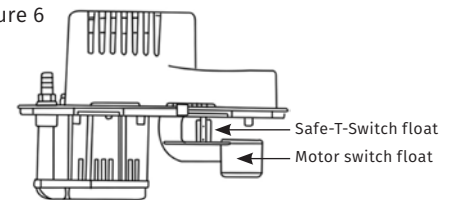
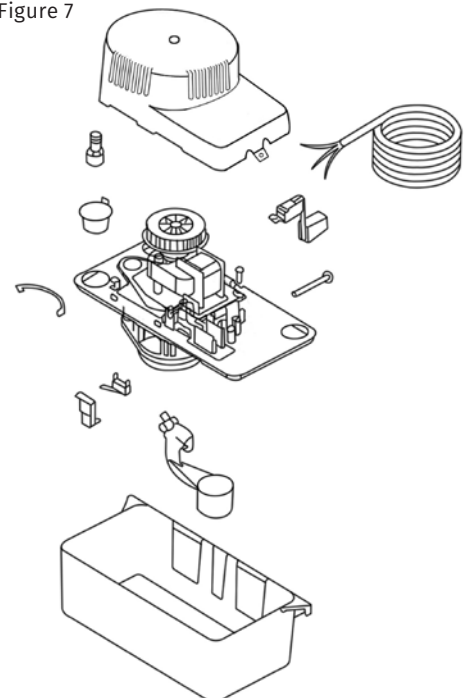

Figure 7



LIMITED WARRANTY

RectorSeal, LLC (“RectorSeal”) warrants the following:

1. LIMITED WARRANTY

The Product subject to this sale will be of good quality and workmanship and conform to the Product’s performance specifications. If during the Warranty Period, the purchaser believes that a Product covered under this Limited Warranty fails to conform to specifications or is defective by reason of faulty design, workmanship or materials, then the purchaser must promptly notify RectorSeal within 15 days of such determination (a “Defect Notice”). RectorSeal will then inspect the Product and determine, in its reasonable judgment, whether an adjustment, repair, or replacement of the Product is warranted, and if so, promptly make the adjustment, repair, or replacement at no additional charge to the purchaser.

RectorSeal may elect to repair the Product on site or have the Product returned to RectorSeal’s premises. If the Product is returned to RectorSeal, risk of loss to the Product will at all times remain with the purchaser, and shipping costs will be borne by RectorSeal where the Product defect is covered by this Limited Warranty.

The foregoing Limited Warranty will be voided in the following conditions:

- I. The Product has not been used or stored (with proper documentation) in a manner consisted with the operating and maintenance instructions of RectorSeal or in compliance with the use or proper purpose intended by RectorSeal (i.e the Product was connected to voltage other than indicated on the nameplate, the Product was allowed to operate dry (fluid supply cut off), the Product was used to circulate anything other than water, etc.);
- II. The installation or application of the Product has not been performed in accordance with RectorSeal’s instructions (i.e. the Product cord was cut off to a length less than 3 feet);
- III. The Product defect has been caused by fire, accident, abuse, misuse (i.e. the Product’s sealed motor housing has been opened), unauthorized alteration, repair, reconstruction or maintenance (including modification of labels or packaging) or the use of sub-standard consumables (ordinary wear and tear excepted);
- IV. The Product defect has arisen from a design, specification, component or material supplied by or on behalf of the purchaser or a third party; or
- V. The Product or any part of the Product has been used or combined with goods, products, hardware or other materials, or has been replaced with a part not supplied or approved by RectorSeal.

2. LIMITED WARRANTY TERM

The duration of this Limited Warranty is 12 months from the Product’s date of sale (the “Warranty Period”).

3. LIMITATION OF LIABILITY AND DISCLAIMER

Before using the Product, the purchaser is solely responsible for determining the suitability of the Product for the intended use, and the purchaser assumes all risk and liability whatsoever in connection therewith. The terms set forth herein are the purchaser’s exclusive remedy for breach of this Limited Warranty. RectorSeal does not warrant any products or services not provided by RectorSeal, or any third-party products or services that incorporate the Products. **RectorSeal will not under any circumstances be liable for any consequential, incidental, special or punitive damages or losses, whether direct or indirect.**

EXCEPT FOR THE LIMITED WARRANTY SET FORTH HEREIN, RECTORSEAL MAKES NO WARRANTY WHATSOEVER WITH RESPECT TO THE PRODUCT, INCLUDING (A) WARRANTY OF MERCHANTABILITY; OR (B) WARRANTY OF FITNESS FOR A PARTICULAR PURPOSE, WHETHER EXPRESS OR IMPLIED, BY LAW, COURSE OF DEALING, COURSE OF PERFORMANCE, USAGE OF TRADE OR OTHERWISE.

Manufactured for

RectorSeal, LLC

2601 Spenwick Drive • Houston, TX 77055, USA • 800-231-3345 • Fax 800-441-0051 • rectorseal.com
3255 Wyandotte St. East, Windsor, ON N8Y 1E9, 519-966-4901

A CSW Industrials Company. RectorSeal, the logos and other trademarks are property of RectorSeal, LLC, its affiliates or its licensor’s and are protected by copyright, trademark and other intellectual property laws, and may not be used without permission. RectorSeal reserves the right to change specifications without prior notice. ©2020 RectorSeal. All rights reserved. R50633-0420